

MINI POWER PACKS
MANUAL OF OPERATION
DD.026 ENG R(1) POWER PACK MANUAL

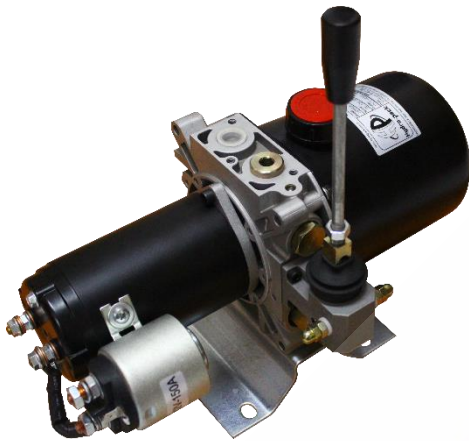
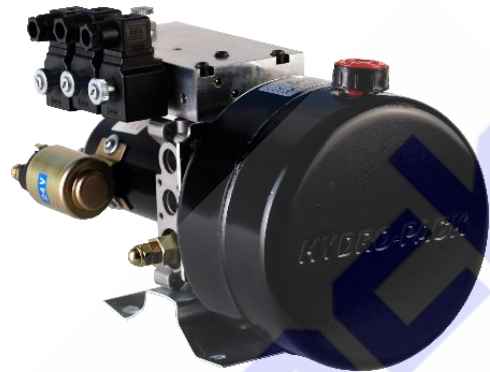
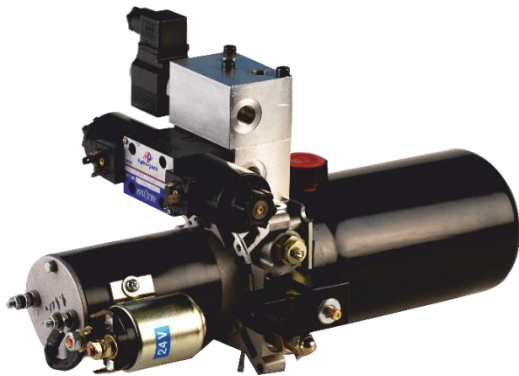

Attention! Before starting the hydraulic power pack operation, it is necessary to get acquainted with all the recommendations included in this manual. The producer does not bear any responsibility for damages occurred because of improper operation of hydraulic power pack or constructive changes.

CONTENTS

I. SECTION A: GENERAL DATA

A1 PRODUCER

A2 INTRODUCTION

A3 CORRESPONDENCE

A4 LABEL

A5 APPLICATIONS

A6 PRODUCTION CONDITIONS AND REQUIREMENTS

A7 TECHNICAL CHARACTERISTIC

A8 NOISE CHARACTERISTIC

A9 WORKING LIQUID

II. SECTION B: SAFETY TECHNICS

B1 RULES FOR TECHNICAL SAFETY

III. SECTION C: DESCRIPTION OF THE HYDRAULIC POWER PACK

C1 MAIN PARTS

C2 ELECTRICAL PARTS

IV. SECTION D: WORKING WITH HYDRAULIC POWER PACK

V. SECTION E: POWER PACK ASSEMBLY

E1 REQUIREMENTS OF THE WORKING AREA

E2 TRANSPORT OF THE HYDRAULIC POWER PACK

E3 POWER PACK PROTECTION

E4 CONNECTING PORTS

E5 CONNECTION TO HYDRAULIC SYSTEM

E6 CONNECTION TO ELECTRICAL SYSTEM

VI. SECTION F: MAINTENANCE OF THE HYDRAULIC POWER PACK

F1 CLEANING OF THE POWER PACK

F2 PRESSURE ADJUSTMENT

F3 PROBLEM SOLVING

VII. SECTION G: WARRANTY

SECTION A: GENERAL DATA

A1 PRODUCER

HYDRO-PACK Mühendislik Makina Hidrolik San. ve Tic. Ltd. Şti.

Sanayi Mah. İzmit San. Sit. 13. Cad. No: 315 İç kapı no: 54 İzmit, Kocaeli, Turkey

Tel: +90 262 335 23 42 Fax: +90 262 335 23 62

E-mail: info@hydropack.com.tr Web: www.hydropack.com.tr

A2 INTRODUCTION

The present manual of operation is intended for users of hydraulic power packs. It contains the necessary information for assembly, initial starting into actuation, maintenance, correct and safety work with the hydraulic power packs.

During the compiling of this manual the experience of the producing company and its specialists are taken into consideration. With special responsibility it is recommended that our indications to be followed up in the part treating the safety precautions at work with the machine.

The operations that request disassembly and assembly of the power pack and electric elements have to be implemented by only qualified and authorized specialists. The repair works and adjustments that are not included in this manual should not be carried out.

A3 CORRESPONDENCE

At occurrence of technical problem, please refer to technical department of Hydropack. (support@hidros.com.tr) At correspondence or phone call with us regarding the bought power pack, please give us the following information so that we can help you better:

- Code of power pack which is on label
- Working voltage and current frequency
- Working pressure
- Displacement of the pump
- Date of production
- Detailed description of the claim
- Working hours

A4 LABEL

Technical information of power pack (Such as motor power, pump displacement, oil tank size, etc.) can be seen on label. Label is located on oil tank.

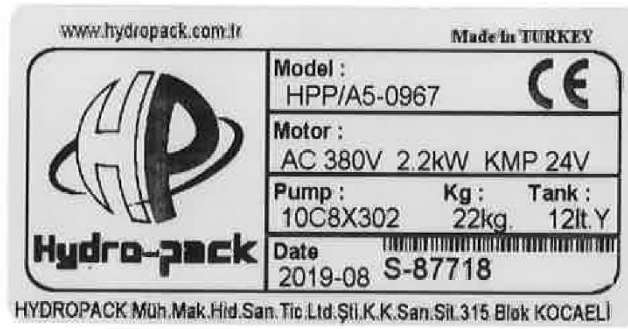

Photo 1. Label of power unit

A5 APPLICATIONS

The hydraulic power pack is intended for integration in hydraulic system of construction building, transport machines, automobiles, manually operated lifting equipments. They are used for single and double acting systems as well. (Tippers, car lifts, dock levelers, tail gates, wheel chair lifts, snowplow, forklifts, industrial automation, etc.)

A6 PRODUCTION CONDITIONS AND REQUIREMENTS

The hydraulic power pack is intended to be used in covered premises as well as at open area at ambient temperature of - 25 to +50°C. Air humidity up to 80 %.

A7 TECHNICAL CHARACTERISTIC

The power packs are designed and accomplished so that they produce a flow rate from 0,4 L/min to 22 L/min depending on the choice of the electric motor (0.5 kW up to 5.5 kW) and hydraulic pump (0,25 cc/rev up to 9 cc/rev) The pressure that can be reached is from 0 to 220 bar depends on the size of the selected components.

A8 NOISE CHARACTERISTIC

The hydraulic power pack does not emit noise higher than 85 dB in accordance to EN 60034–9.

A9 WORKING LIQUID

The oil tank must be filled with new, filtered mineral based ISO 6743/4 fluid. Hydraulic oils at mineral or synthetic base with viscosity rate from 15 to 68 cST at temperature of 40 °C. Hydraulic fluid may change regarding working climate. Please do not use motor oil, diesel oil or water as fluid in the system. Class of filtration -9 NAS 1638.

Hydraulic fluid should be changed after 6 months or 1 year depends on usage in application. Suction filter needs to be cleaned as well.

If there is decrease on fluid level, additional oil should be put in.

SECTION B: SAFETY TECHNICS

B1 RULES FOR TECHNICAL SAFETY

To work with the power pack it could be allowed only personel who is acknowledged with the rules for actuation of electrical equipments and equipments working under pressure.

For safety functioning of the hydraulic power pack it is necessary to be kept the following rules:

- It is not allowed an actuation of the power pack with replaced cap of the terminal connecting box of the motor or using connectors on the coils of the solenoid valves that are not of the same type like these with which the power pack is accomplished.
- The connection has to be done from a qualified electrician. During the connection it should be observed the direction of rotation of the electric motor (the arrow at the cover of the el. motor indicates the correct direction of rotation).
- Hydraulic connection must be carried out carefully. There are letters on top of the main manifold. P refers to pump line (pressure) and T refers to tank line (return).
- The selection of the pipelines must be complied with the system pressure and flow rate.
- The tube connectors must be fixed tightly. It should not be allowed any fluid leakage at the outer surfaces. Proper sealing elements should be used.
- It is not permitted the replacement of the air breather with plug.
- It is not permitted pressure relief valve readjustment to a higher pressure.
- The power pack must be fixed to a basement or to a stable frame.
- It is not allowed the power pack use in explosion – hazardous and combustable environment.
- Lack of oil may cause a damage to hydraulic pump.
- Mono phase and three phase AC motor terminal box covers should be closed.
- Rotation of the AC motor from fan side view is right rotation. Hydraulic pump rotation from shaft view is clockwise.
- Insulated cables must be used in connection.
- Power pack assembly should not be carried out in watery environment.
- DC motor + & - poles should not contact each other.
- DC motor cable ends must be insulated.
- DC motor should not operate without starter assembled on it.
- There are breathers with red color on oil tanks. Blind plugs should not assemble on these breathers.
- Hose diameters should not be too small.

SECTION C DESCRIPTION OF THE HYDRAULIC POWER PACK

C1 MAIN PARTS

The power pack is consisted on the following main elements:

- Electric motor
- Central manifold (Die casting aluminum alloy)
- Hydraulic gear pump
- Oil tank
- Filter

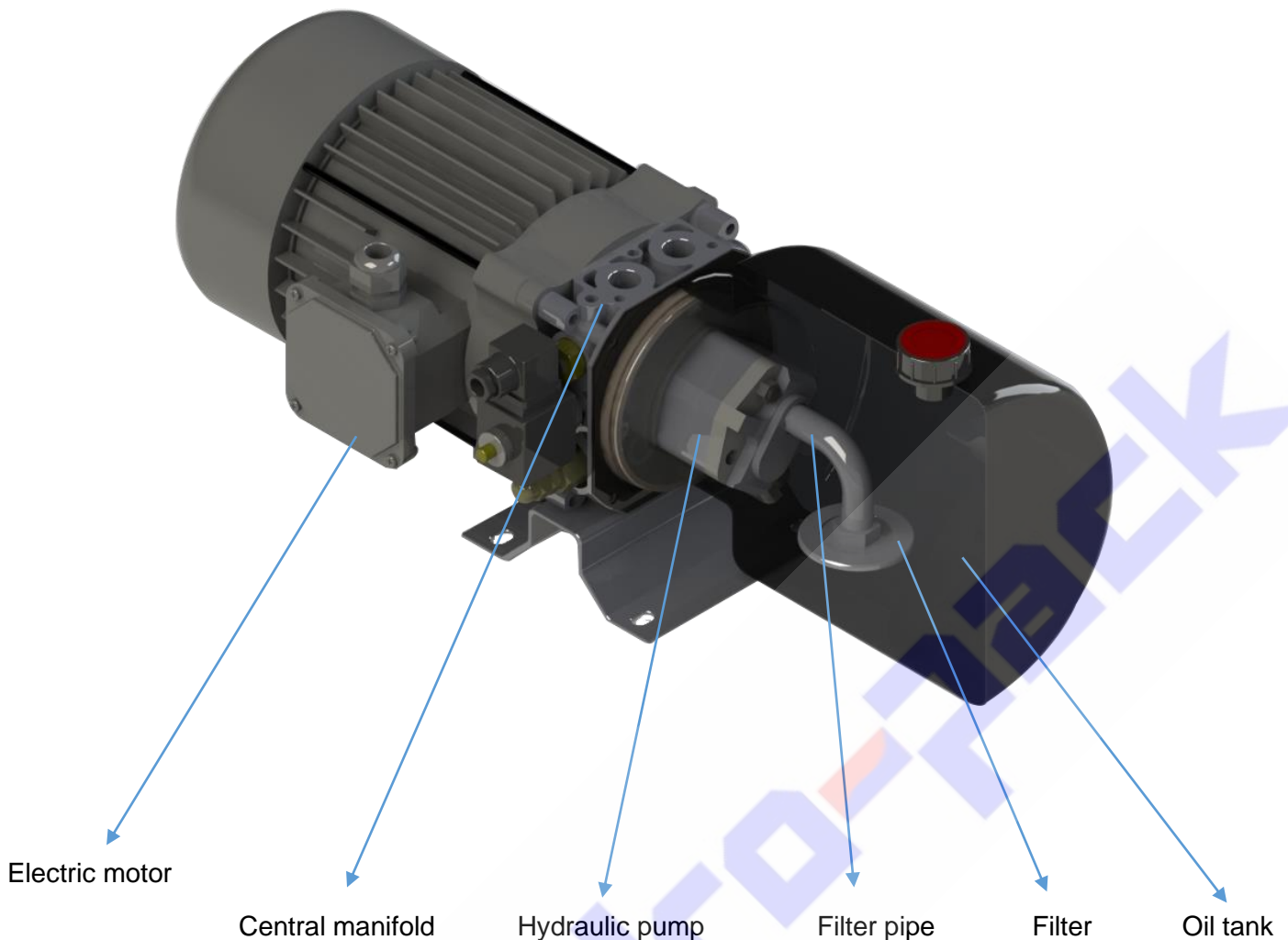

Photo 2. Main components of mini power pack

At switching on the power of the electric motor, it drives the gear pump. The pump sucks the working liquid from the tank and directs it to the valve block and from there to the implementing components of the power pack. The pressure in the system is regulated by the pressure relief valve which is built in main block. Other hydraulic blocks can be assembled to the power pack according to customer's demand.

C2 ELECTRICAL PARTS

The hydraulic power pack is assembled with:

- Electric motor
- Starter (Used for DC motors only)
- Solenoid valves (Optional)

The electric motor is three phase type or mono-phase for AC. Regarding DC motors, working voltages are 12 or 24 V standard in range.

The solenoid elements are cartridge type. Their coils can operate under voltages of 12, 24, 110 or 220 V. The connectors are made under DIN 43650.

SECTION D WORKING WITH HYDRAULIC POWER PACK

The power pack work is determined by the machine at which it is integrated. At work with the power pack it is not allowed the presence of leakage of working fluid on the outside surfaces. The power pack is switched when the motor is supplied with the necessary voltage. The control is effected by proper combination of switching on the motor and the solenoid valves.

SECTION E: POWER PACK ASSEMBLY

E1 REQUIREMENT OF THE WORKING AREA

The power pack must be mounted using M10 holes if there is no mounting bracket. The working area around the power pack must be free and an access to the oil filler, to the valves and the unloading throttle has to be ensured. The power packs must not be placed in closed areas that may prevent its cooling. The power pack should not contact with any parts that may vibrate and transmit noise.

E2 TRANSPORT OF THE HYDRAULIC POWER PACK

The power pack can be transported with any kind of covered transport. At its transporting it should be observed the recommendations on the carton. If there is oil inside the tank during transportation, air breather should be replaced with blind plug or oil should be pour out before transport.

E3 POWER PACK PROTECTION

The hydraulic power pack is taken out of the carton. The polyethylene packing is removed of it. The safety plugs are replaced of the supply ports.

E4 CONNECTING PORTS

There are two letters on main manifold which refer to pump (pressure) and tank lines. P refers to pump line and T refers to tank line. Both ports are G 3/8" as standard. Max. tightening torque of fittings is 65 Nm.

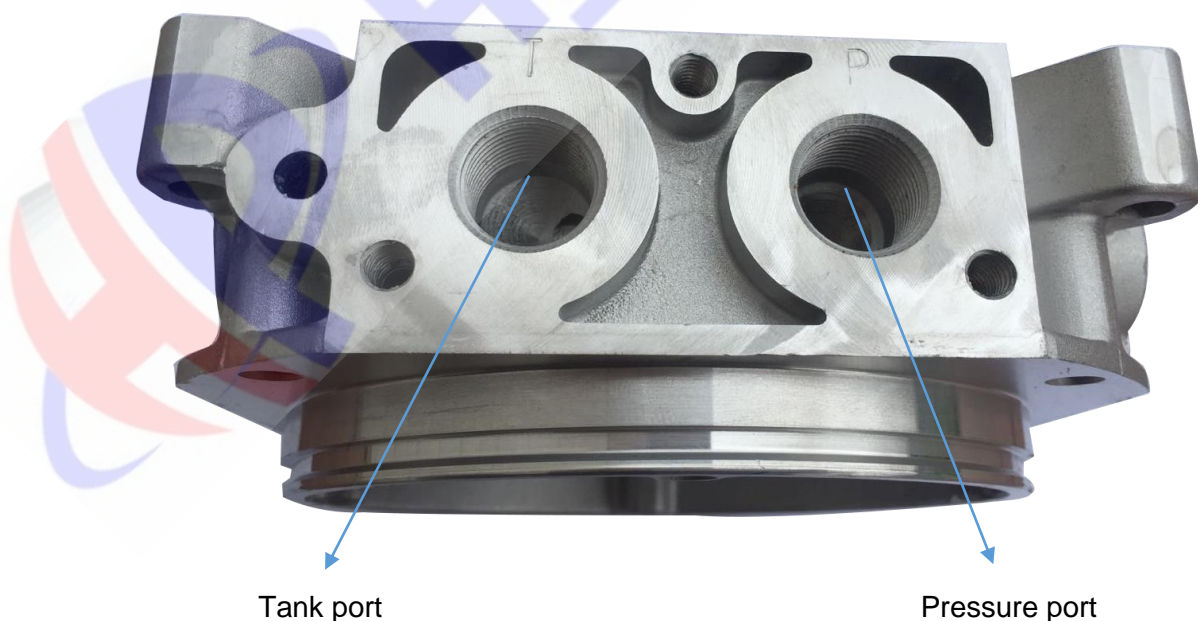

Photo 3. Connection ports on central manifold

E5 CONNECTION TO HYDRAULIC SYSTEM

The pipelines from the power pack are connected to the implementing components of the machine. Hydraulic circuit and technical information can be found on technical drawing. After the final installation of the power pack, the clean working liquid is poured into the tank to the indicated level.

E6 CONNECTION TO ELECTRICAL SYSTEM

The cap of the motor terminal connecting box is removed. The nuts of the terminals are unscrewed. The cable shoes are connected to the terminals. Then the nuts are screwed and reliably tightened. The motor is nullified. The cap is placed at the terminal connecting box. The coils of the solenoid valves are connected in the analogical manner. Motor rotation must be checked carefully.

The connecting of the power pack to the electrical system should be done by a certified electrician as the rules for safety work with electrical equipments should be observed. Please refer to producer for electrical schema. For keeping electric motor, you must use current relay (100 mA), thermic relay and main circuit cutoff switch. After electrical connection have been made, please check the motor rotation by executing short pulses of right rotation (from fan side) 1 second each (max.).

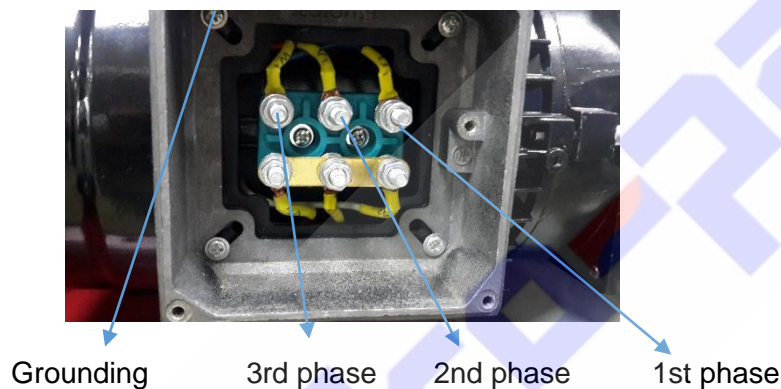
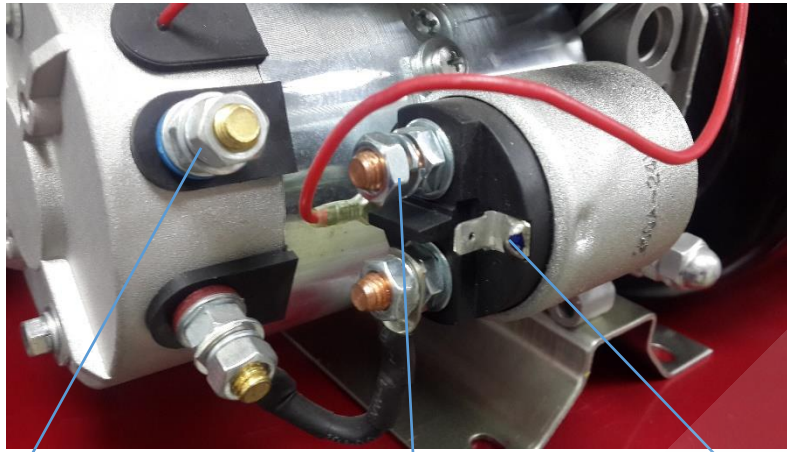

Photo 4. Connection on 380 V AC three phase motors



Photo 5. Connection on 220 V AC mono phase motors*

* If mono phase motor operates in anti-clockwise rotation, please kindly check instructions located on terminal box cover to make it right rotation.



(-) from battery

(+) from battery

For switch/remote etc.

Photo 6. Connection on DC motor

For detailed information, please refer to “DD.043 R(0) Remote control connection on power units” document.

SECTION F MAINTENANCE OF THE HYDRAULIC POWER PACK

F1 CLEANING OF THE POWER PACK

The cleaning of the power pack is made by textile cloth without using any cleaning substances or solvents. The cloth should not left any filaments on the treated surfaces. Once yearly it is necessary the oil to be changed in the tank to be cleaned. The oil changing is done in the following way:

- The pressure is unloaded in the system.
- The power pack is switched off from the electric installation.
- The pipelines are disassembled. The screws by which the power pack is fixed to the basement are unscrewed.
- The power pack is placed vertically on the tank and the fixing screws are unscrewed and also the tank brackets are replaced.
- The electric motor is placed outside together with the central manifold and the pump. The old oil is poured out and the internal surface of the tank is cleaned. The suction filter is cleaned also.

After cleaning, the electric motor with the central manifold are placed on the tank. The fixing screws and the brackets are screwed. The assembled power pack is installed on its working position. The working liquid is poured up to the indicated level on the stick. The air breather must be closed firmly. The pipelines are assembled and the power pack is connected to electrical system in accordance to the way of application.

Dirty oil sharply decreases the life time of power pack.

F2 PRESSURE ADJUSTMENT

The pressure adjustment in the hydraulic power pack is made by means of pressure relief valve which is built in on main manifold. The pressure adjustment is effected in the following order:

A pressure gauge is installed at port “P”. The nut of the adjusting screw is unlocked. The adjusting screw is unscrewed up to its end.

The hydraulic power is switched on and the adjusting screw is activated (clockwise to increase, anti-clockwise to decrease) until it reaches the desired pressure. Then the nut is locked.

For detailed information, please refer to “DD.030 ENG R(0) Adjusting relief valve pressure on power pack” document.



Photo 7. Pressure relief valve

Attention! Please do not pass max. working pressure indicated on technical drawing.

F3 PROBLEM SOLVING

| PROBLEM | REASONS | METHOD OF ELIMINATION |
|--|---|--|
| Not sufficient pressure | <ul style="list-style-type: none"> • Lack of oil inside the tank • Damaged pressure relief valve • Damaged solenoid operated valve • Damaged Hydraulic pump • Filter pipe type is incorrect • Filter is blocked • Air on suction line • Contamination | <ul style="list-style-type: none"> • The oil is filled up • Readjustment of the relief valve • Replacement • Replacement • Replacement • Replacement • Elimination of the air |
| No pressure | <ul style="list-style-type: none"> • Gear pump doesn't operate properly • Electric motor rotation is wrong • Electric wiring is wrong | <ul style="list-style-type: none"> • Repair or replacement • Make sure correct rotation • Check wiring |
| Non-performance of the function | <ul style="list-style-type: none"> • Damaged solenoid valve • Damaged check valve • Damaged pressure relief valve • Damaged hydraulic pump | <ul style="list-style-type: none"> • Replacement |

All power packs are tested 100% before delivery to customer. Please kindly contact us for all questions.

Please feel free to fill information below and send to us for custom designed mini power units.

| | |
|---|--|
| Application | |
| Number of cylinders | |
| Type of cylinders | <input type="checkbox"/> <i>(Single acting)</i> <input type="checkbox"/> <i>(Double acting)</i> <input type="checkbox"/> <i>(Telescopic)</i> |
| Number of stages if cylinder is telescopic | |
| Assembly of cylinders | <input type="checkbox"/> <i>(Vertical)</i> <input type="checkbox"/> <i>(Horizontal)</i> <input type="checkbox"/> <i>(Angled)</i> |
| Please specify angle if cylinder operates angled | |
| Operating of cylinders | <input type="checkbox"/> <i>(Cylinders operate at the same time.)</i> <input type="checkbox"/> <i>(Cylinders operate independently.)</i> |
| Max. load in the system | |
| Cylinder bore diameter (If cylinder is telescopic, please specify bore diameter and stroke of each stage.) | |
| Cylinder stroke | |
| Cylinder opening time [seconds] | |
| Required motor voltage | |
| Power pack assembly | <input type="checkbox"/> <i>(Vertical)</i> <input type="checkbox"/> <i>(Horizontal)</i> |

SECTION G WARRANTY

The producer guarantees the conformance of the product to the standard and technical documentation and its work capability at actuation complied with the present manual.

Please do not take out product label on oil tank during warranty period.

The guarantee period is 12 months from the date of starting in operation, but not more than 18 months from the purchase date.

The producer undertakes to eliminate the defects occurred because of its fault.

The guarantee conditions are not be carried out if the user has made a repair without permission and has not kept the clauses mentioned in the present manual.

The guarantee engagements of the producer will be implemented in its factory or in authorized service by it.

| | |
|---------------------------|---------|
| PRODUCT CODE | HPP ... |
| SERIAL NO | |
| DATE OF PRODUCTION | |

Warranty is only valid on document which has date, stamp and signature information.

RELEASE DATE:

STAMP AND SIGNATURE

HYDRO-PACK Mühendislik Makina Hidrolik San. ve Tic. Ltd. Şti.

Sanayi Mah. İzmit San. Sit. 13. Cad. No: 315 İç kapı no: 54 İzmit, Kocaeli, Turkey

Tel: +90 262 335 23 42 Fax: +90 262 335 23 62

E-mail: info@hydropack.com.tr Web: www.hydropack.com.tr